

CANASTA RECICLADORA INTELIGENTE

PROTOTIPO

DIMENSIONES

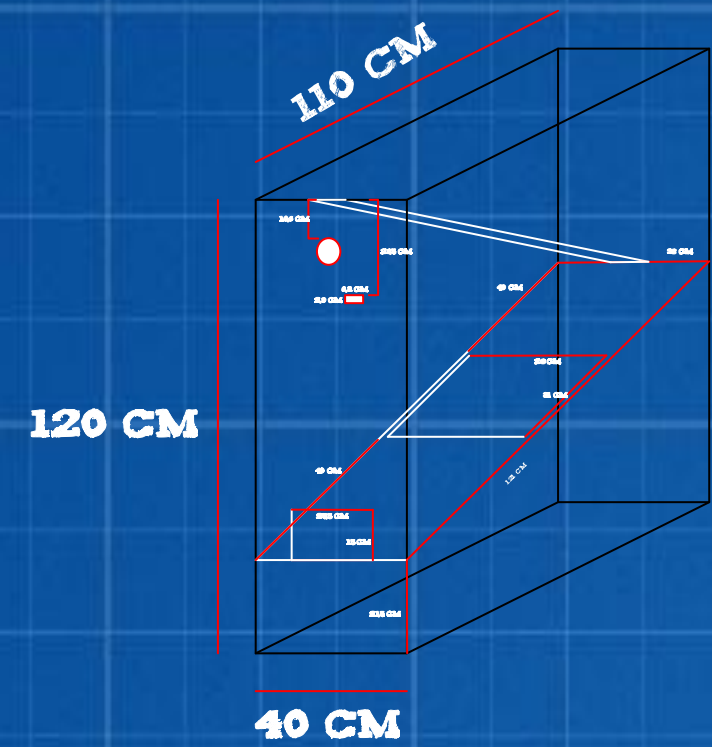

ESTRUCTURA EXTERIOR

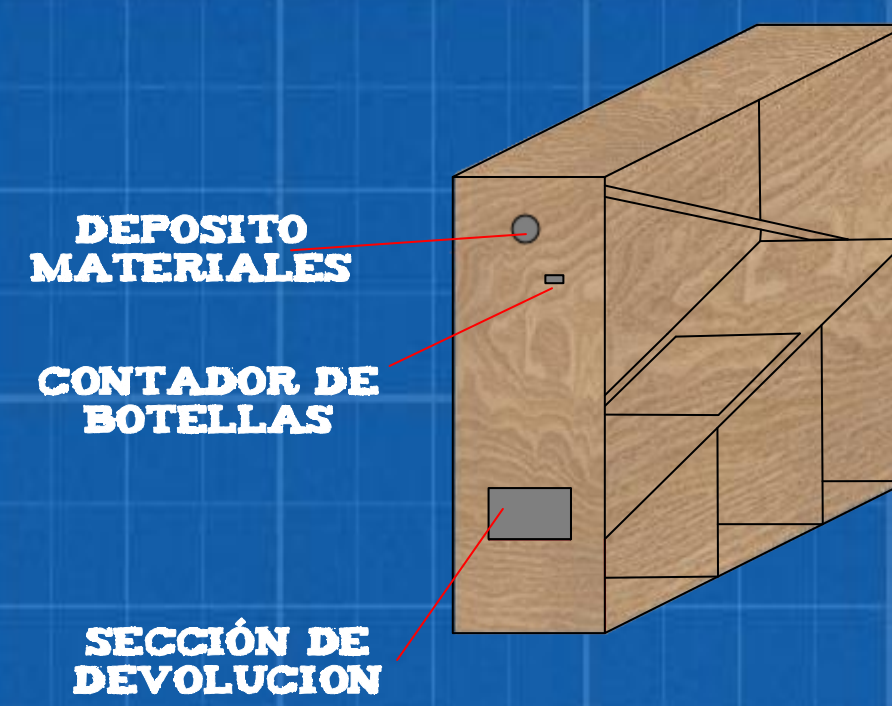

ESTRUCTURA INTERIOR

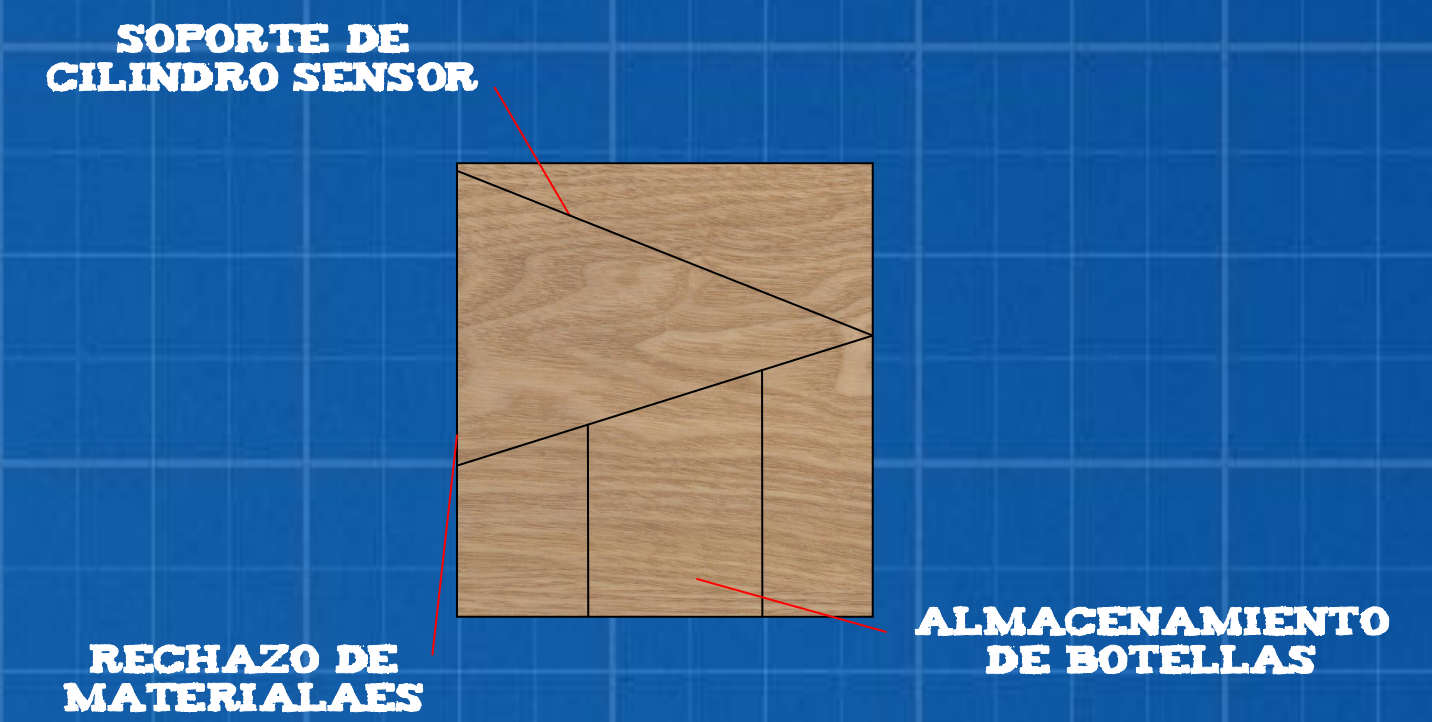

MONTAJE FASE II

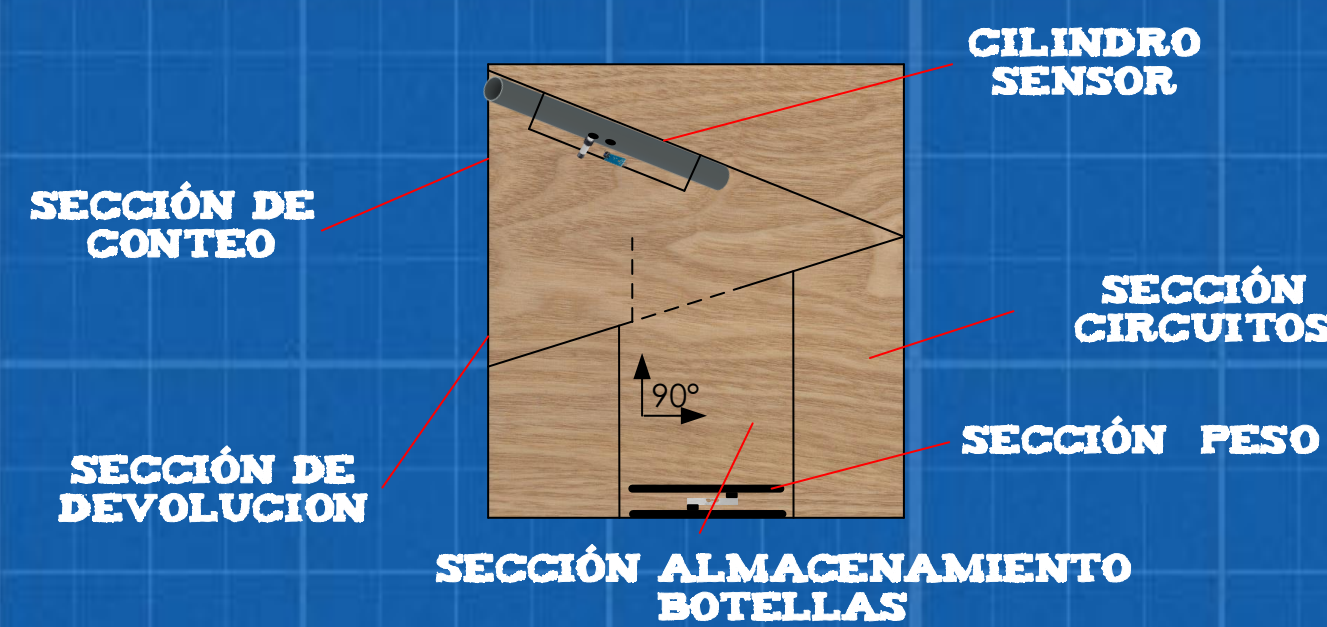

MONTAJE FASE I

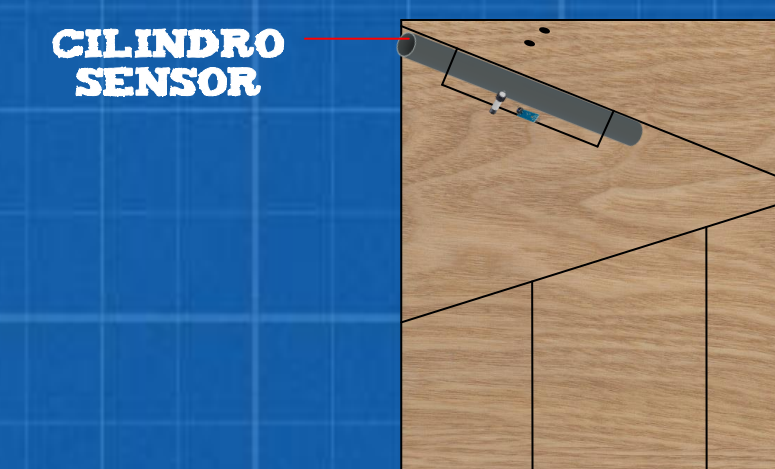

PROTOTIPO FINAL



ELEMENTOS



CANASTA RECICLADORA INTELIGENTE

ESTRUCTURA FRONTAL MEDIDAS

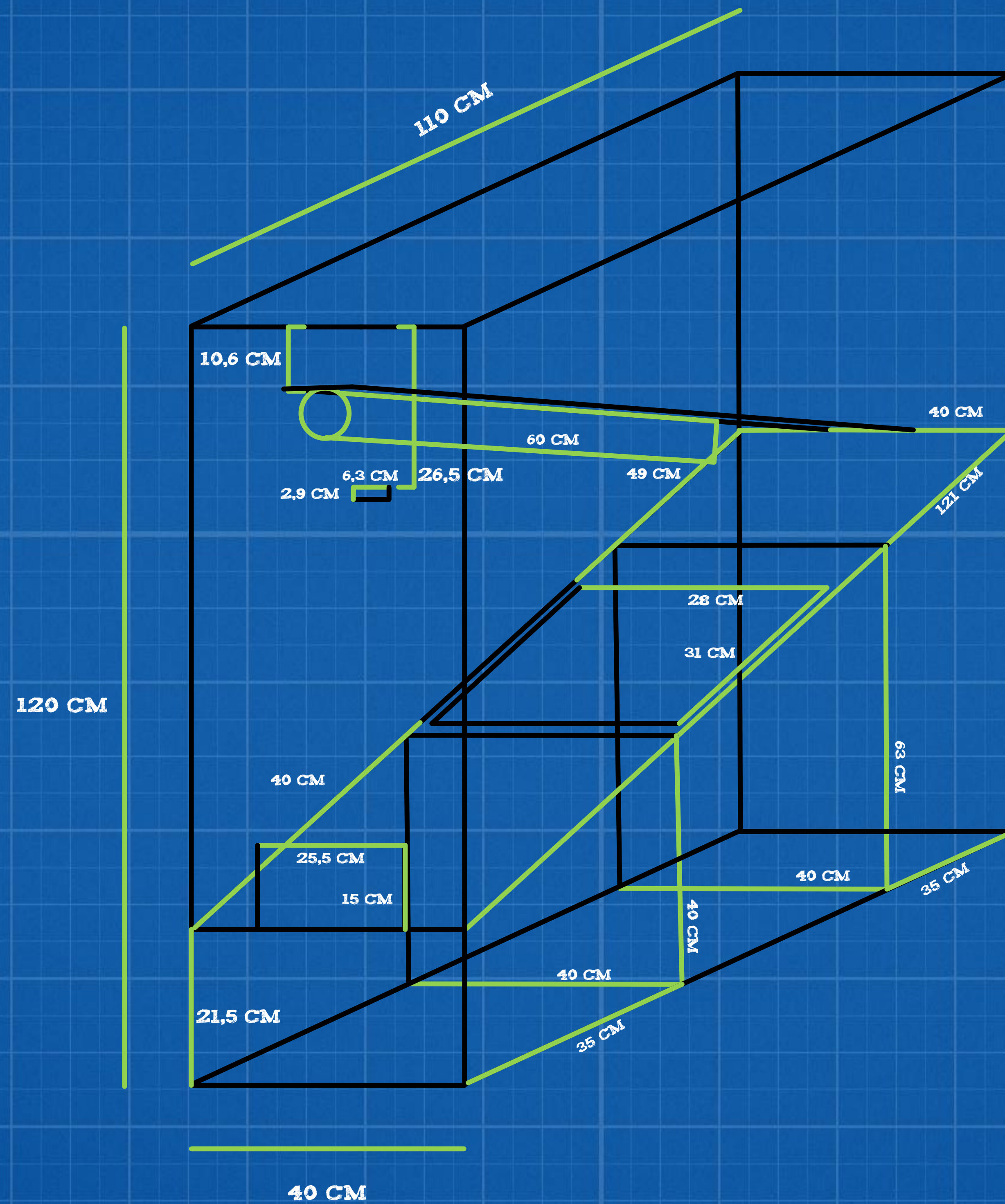

CANASTA RECICLADORA INTELIGENTE

ESTRUCTURA ENSAMBLADA

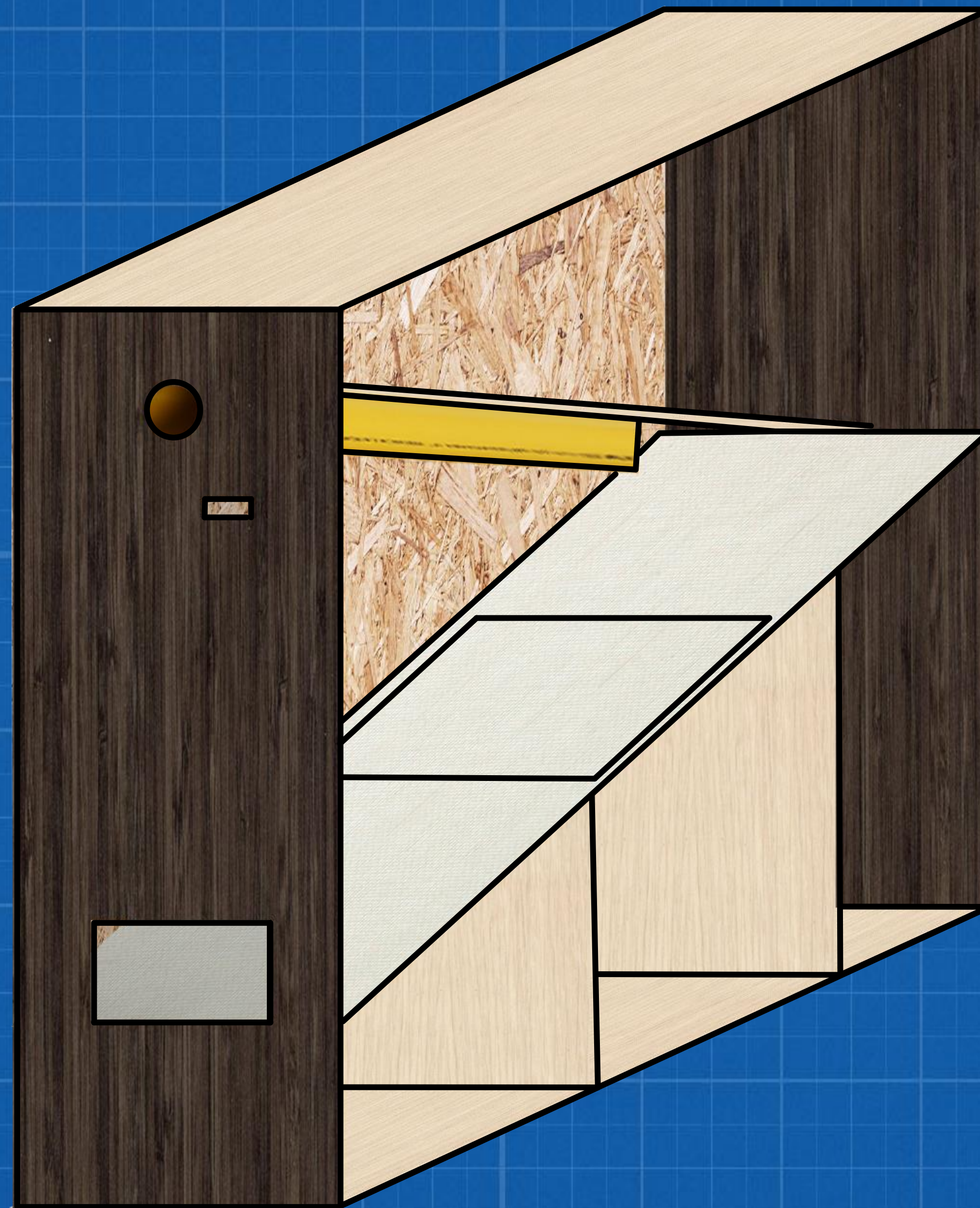

CANASTA RECICLADORA INTELIGENTE

ESTRUCTURA LATERAL MEDIDAS

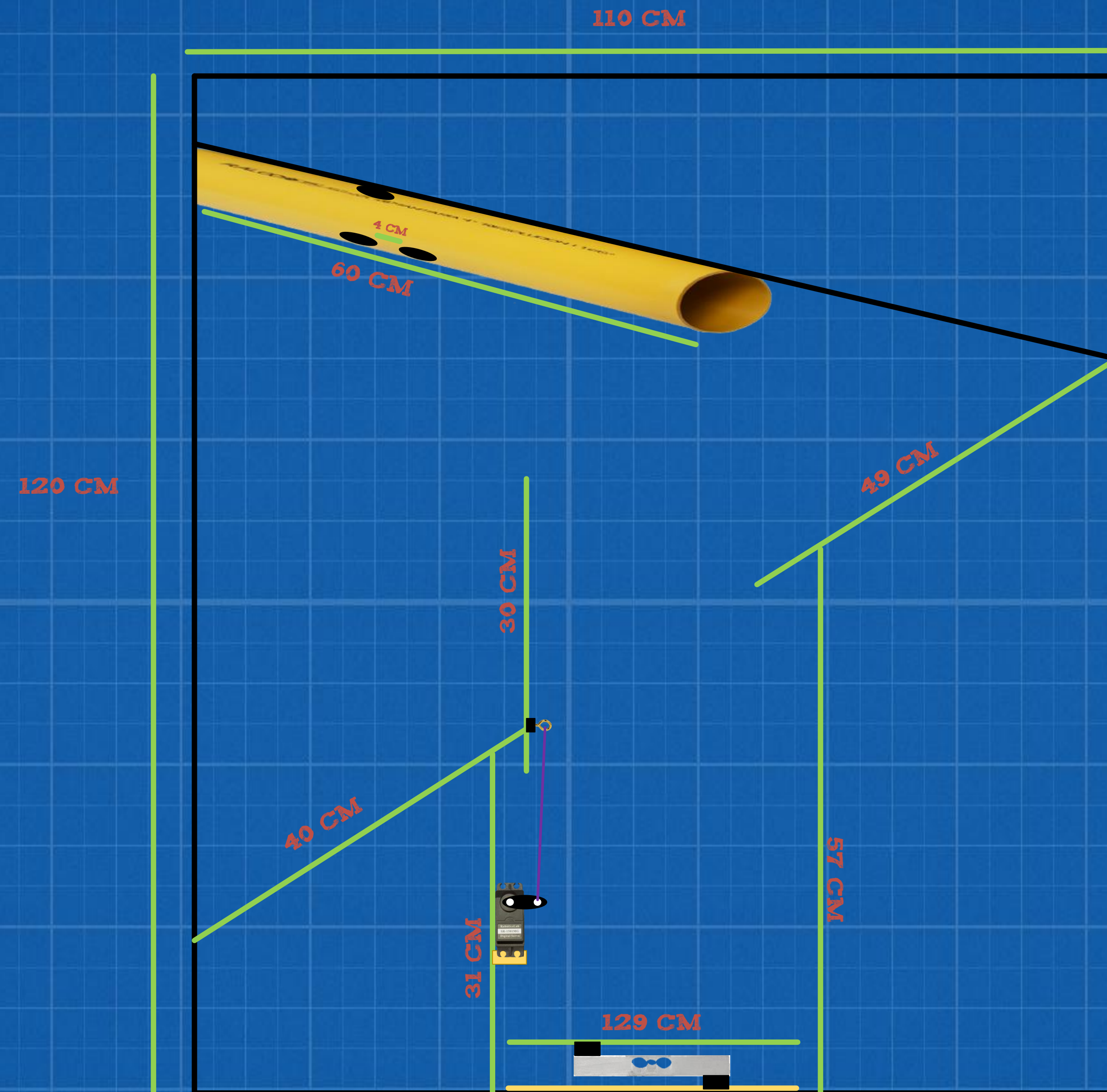

CANASTA RECICLADORA INTELIGENTE

ELEMENTOS MONTADOS

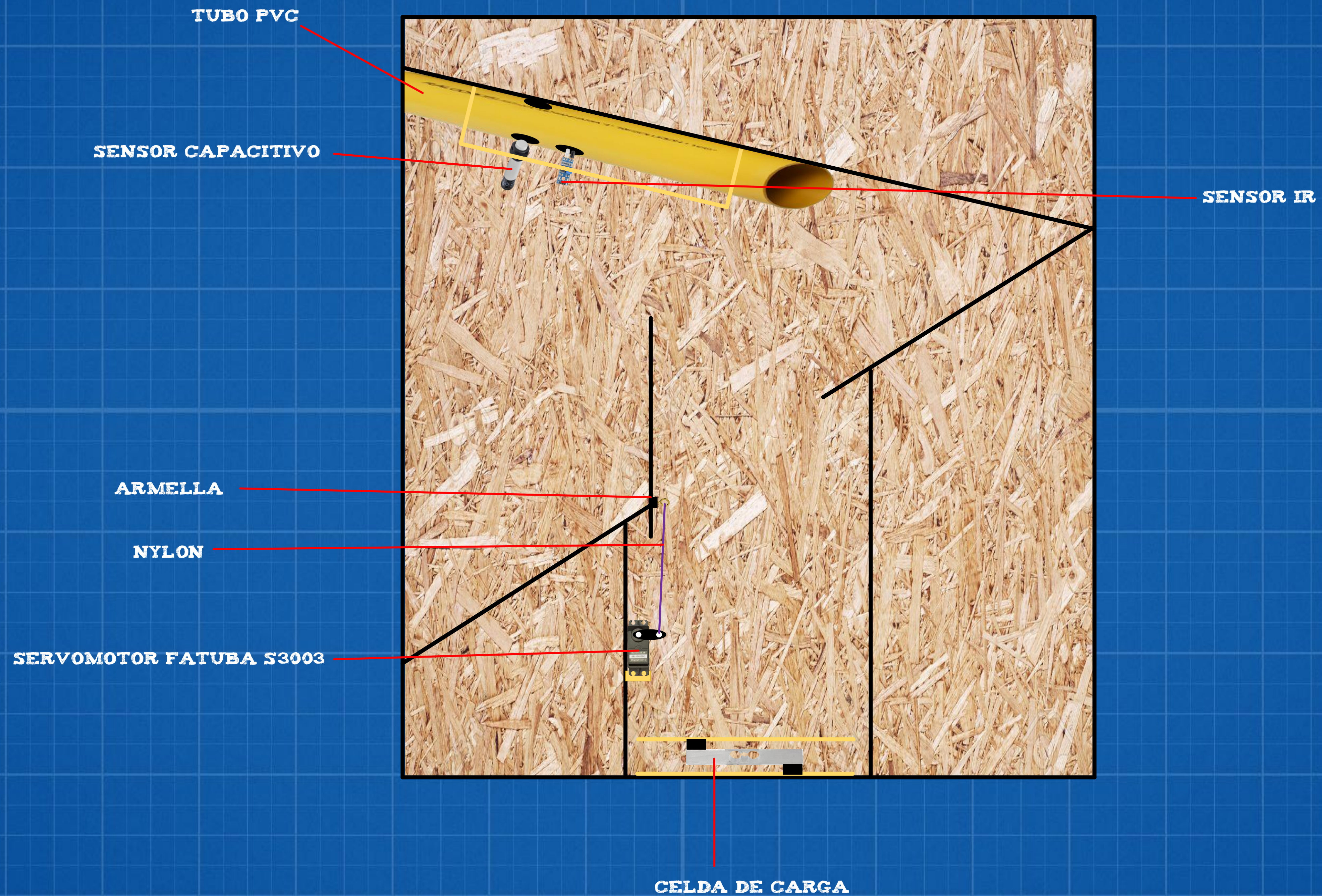

CANASTA RECICLADORA INTELIGENTE

SECCIONES

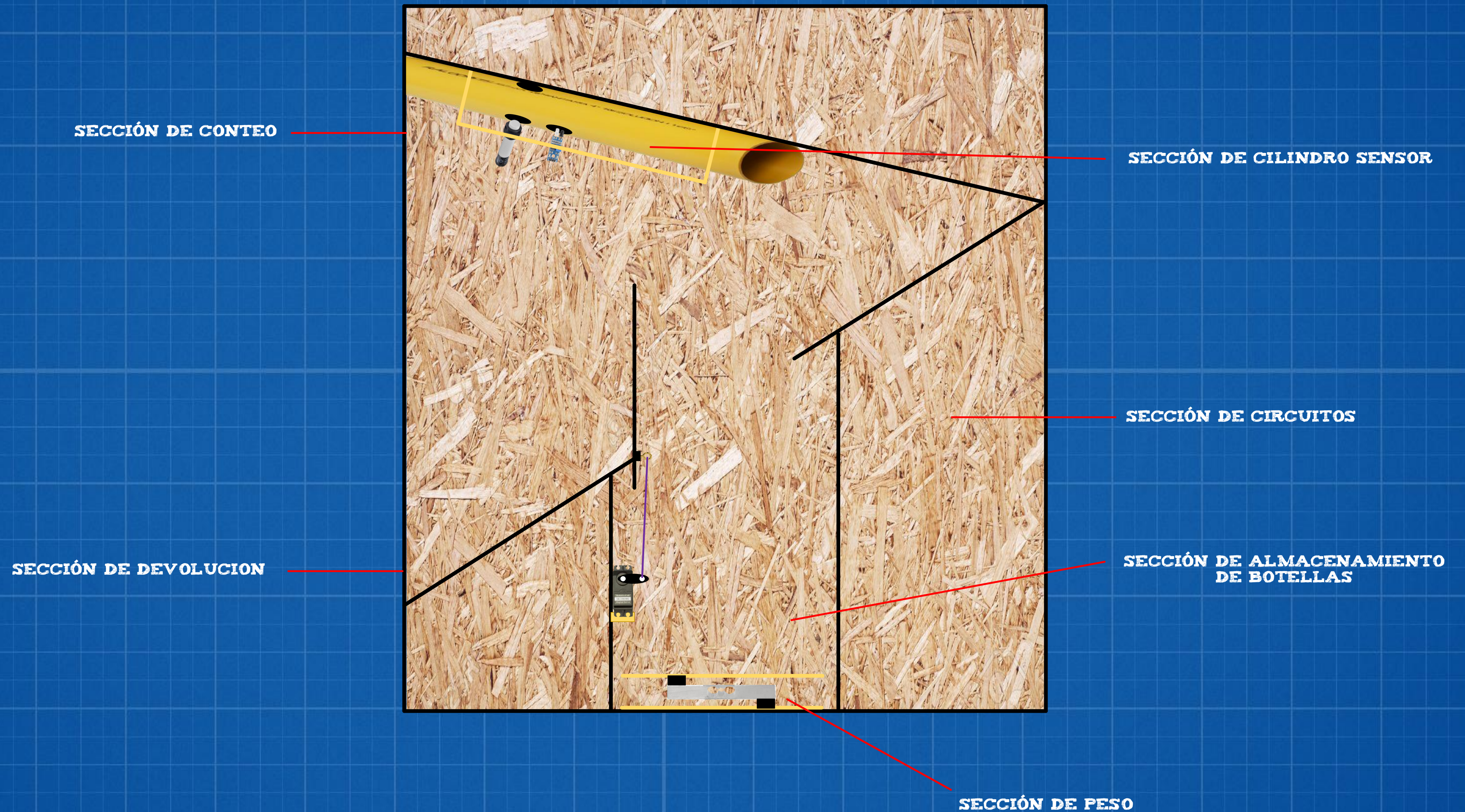

CANASTA RECICLADORA INTELIGENTE

ESTRUCTURA CUBIERTA



BASCULA

CELDA DE CARGA

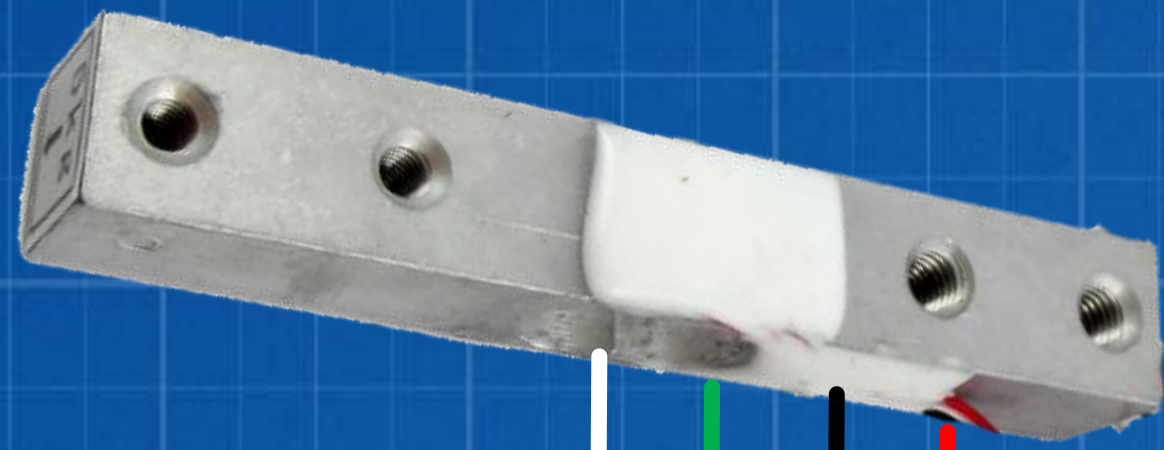

MODULO HX711

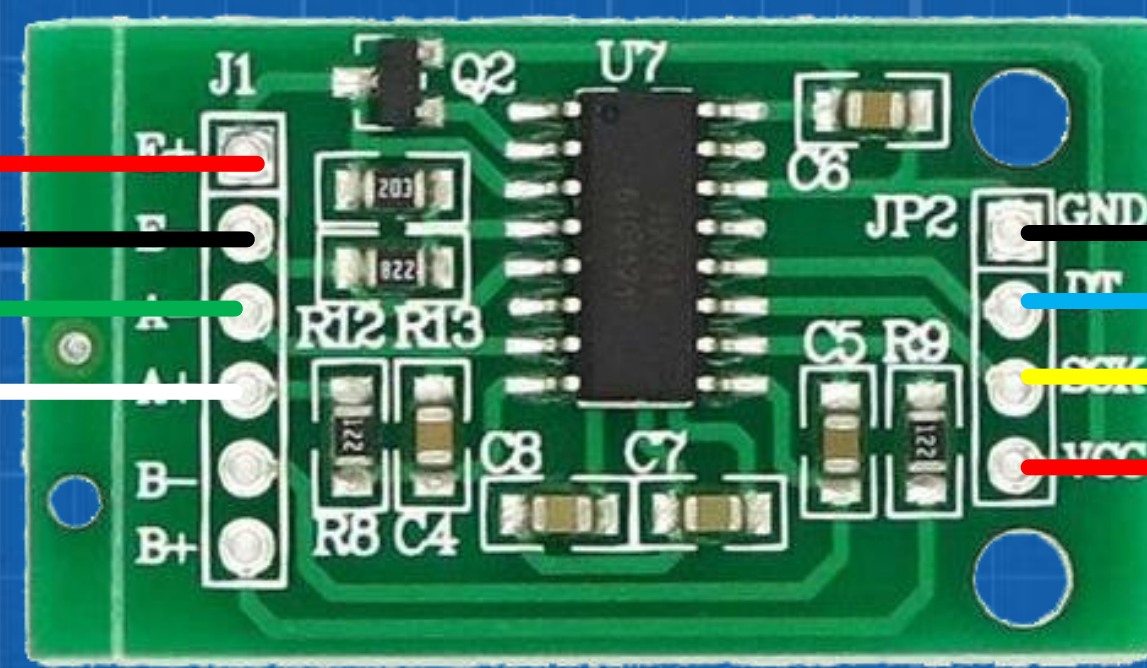

ARDUINO UNO

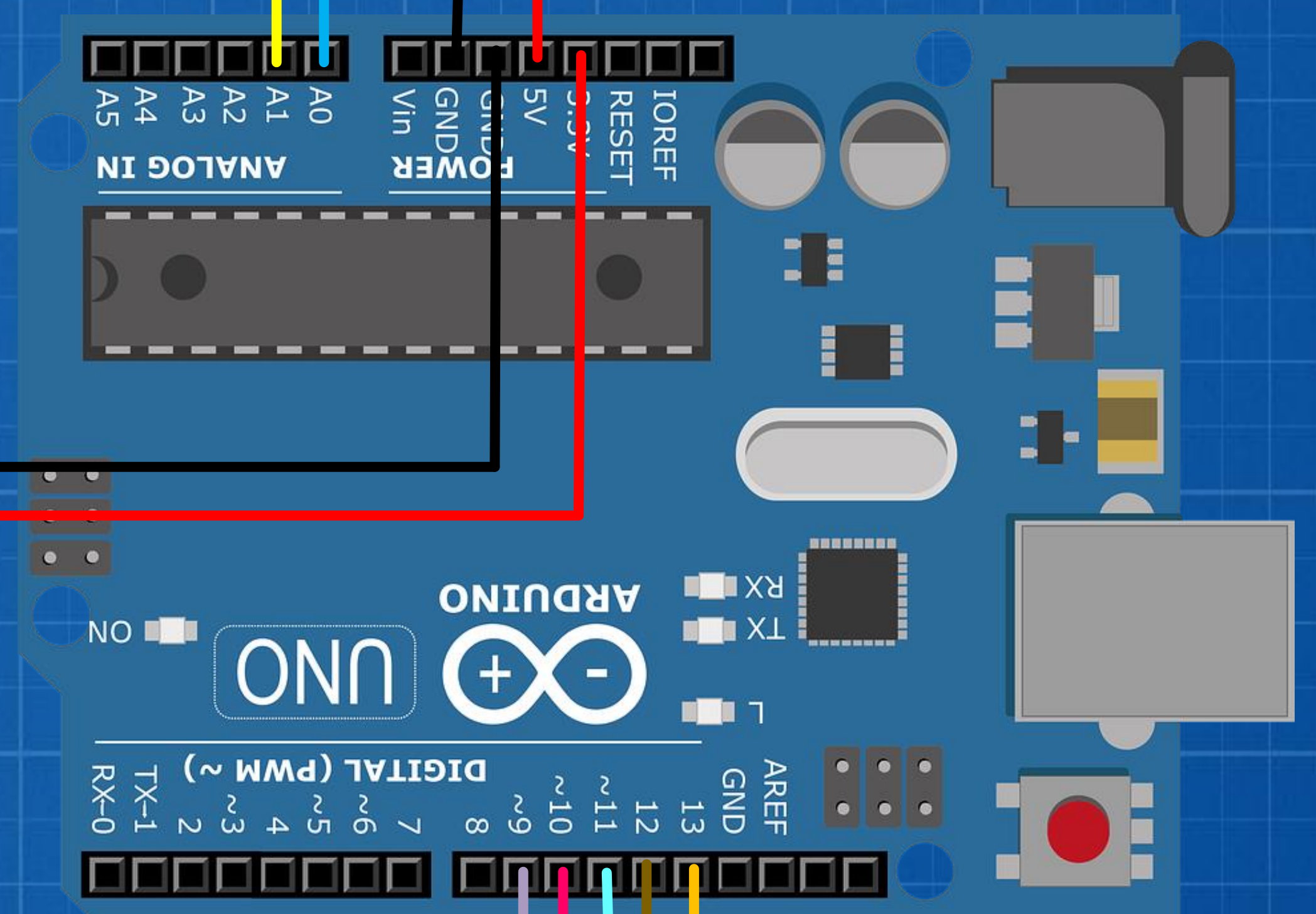

MODULO ETHERNET ENC28J60

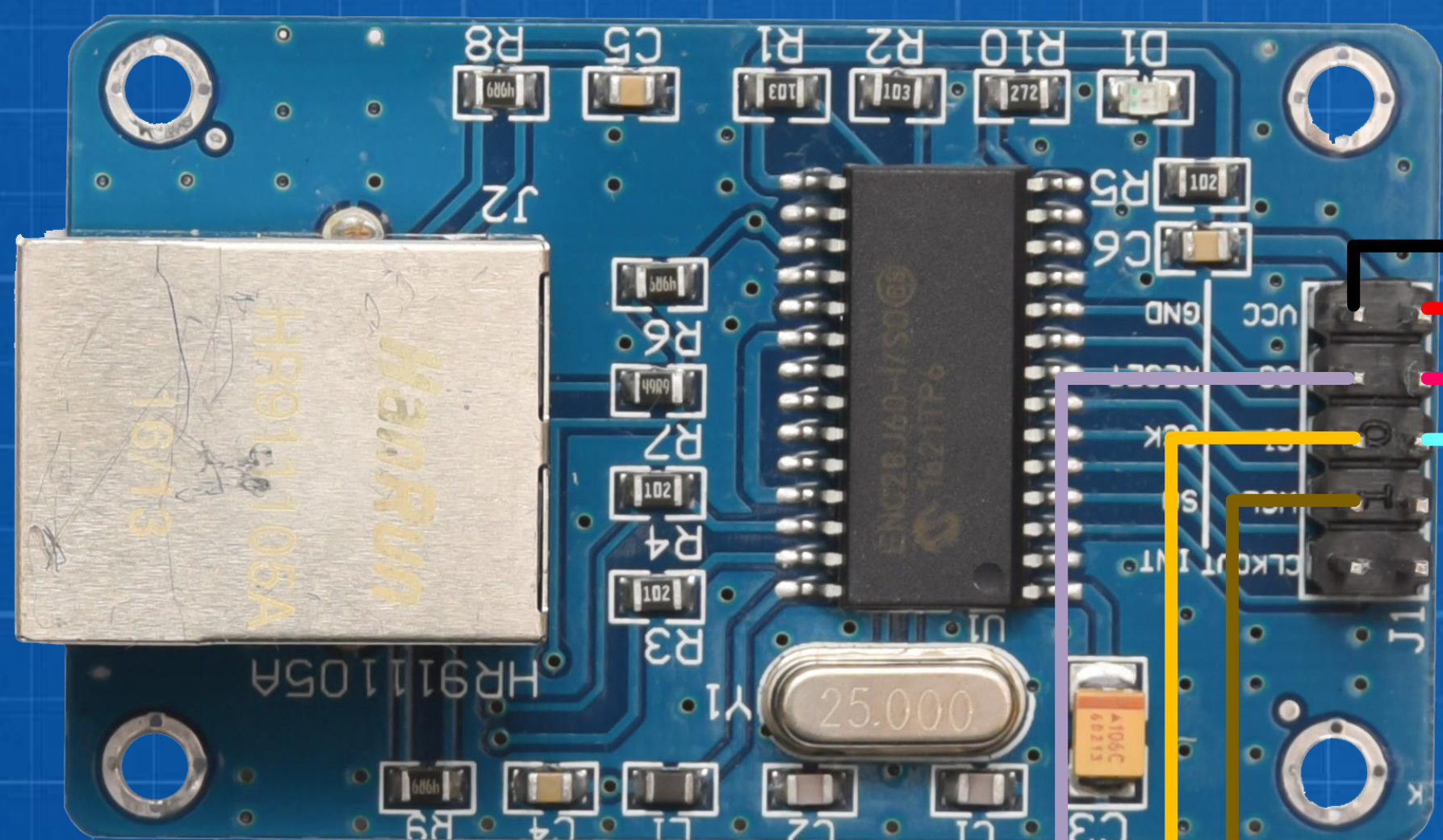

SENSORES + COMPUERTA

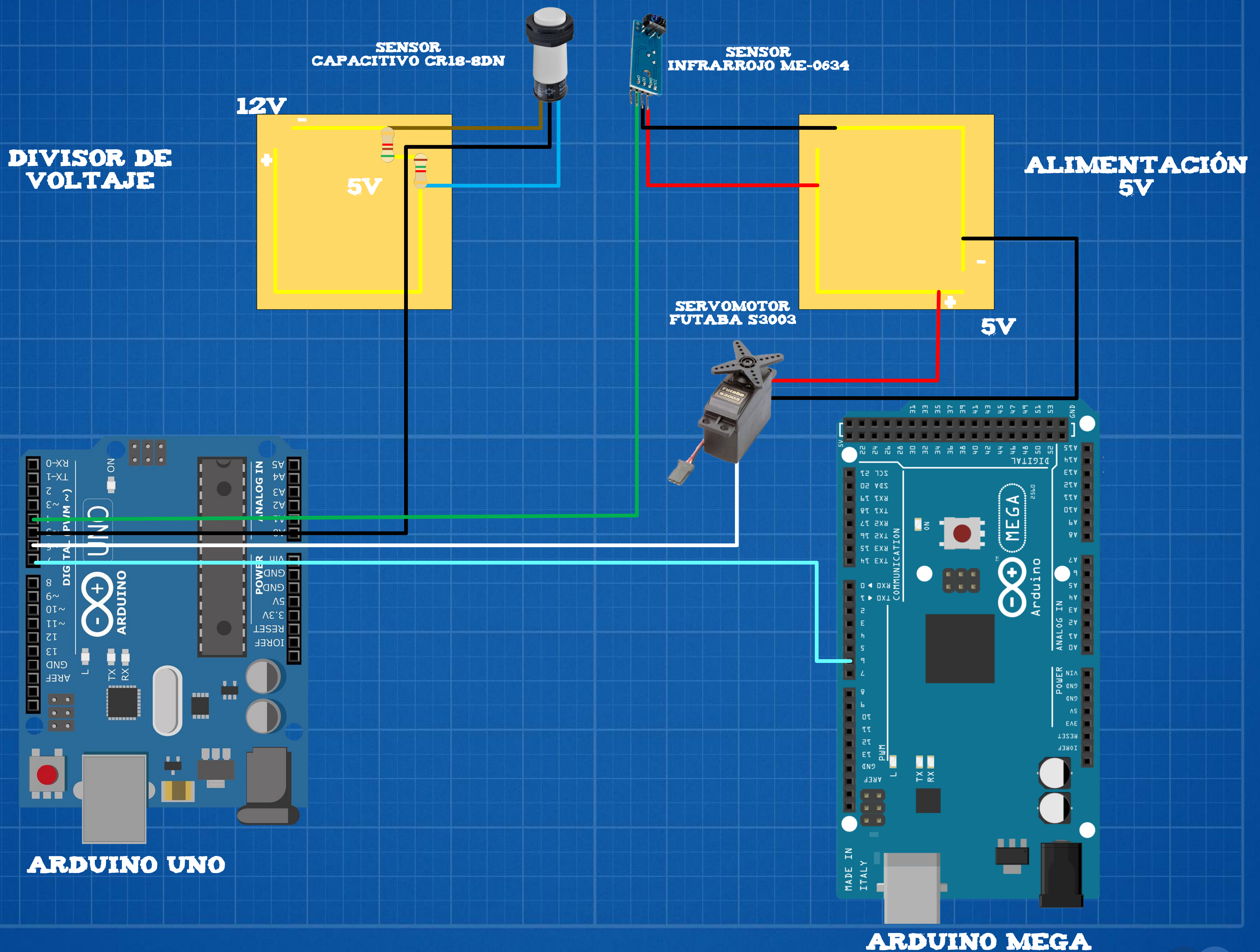

SENSORES + COMPUERTA + CONTADOR

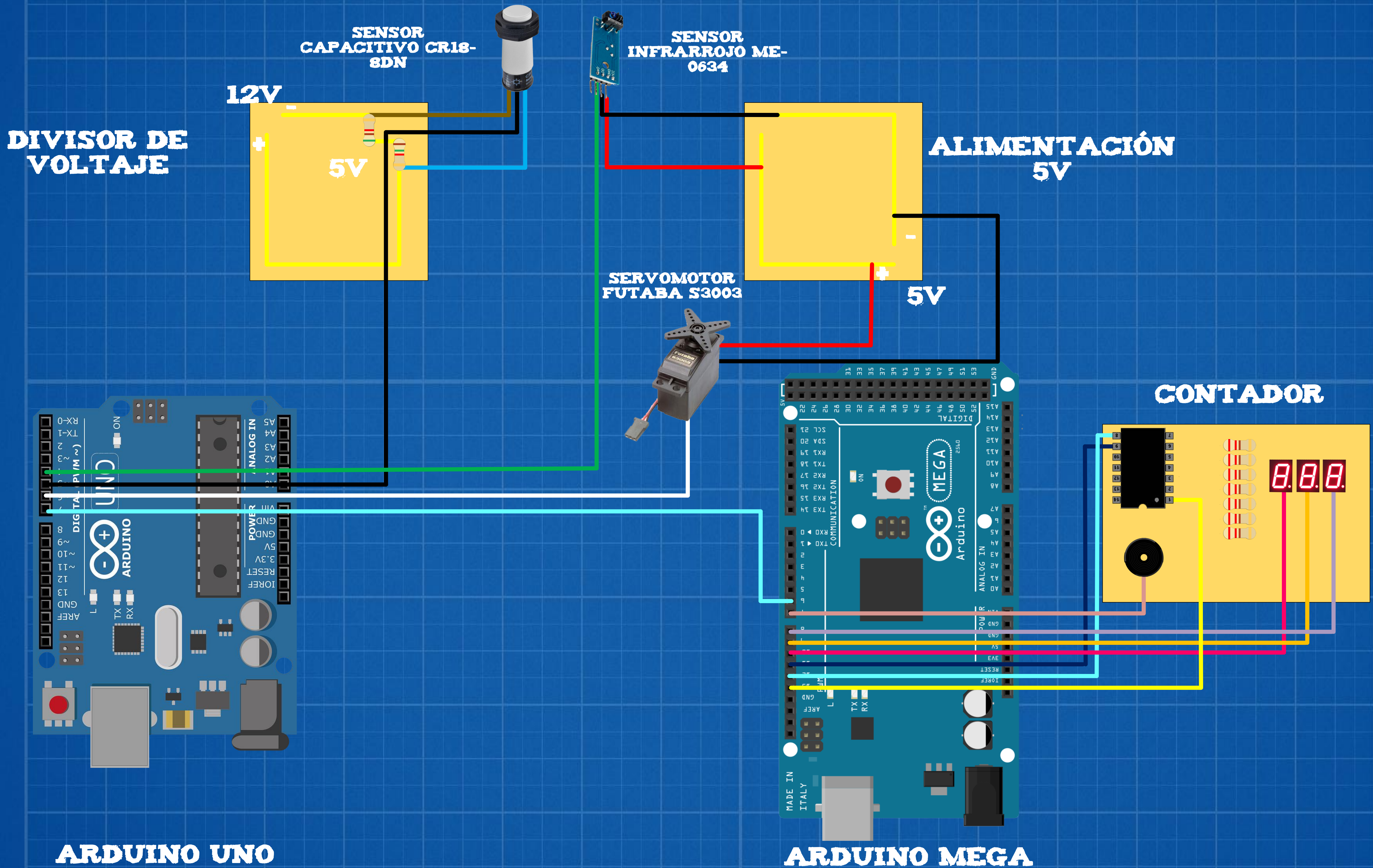

CANASTA RECICLADORA INTELIGENTE

ESTRUCTURA TERMINADA



CANASTA RECICLADORA INTELIGENTE

ESTRUCTURA FRONTAL MEDIDAS (IMPRIMIR)

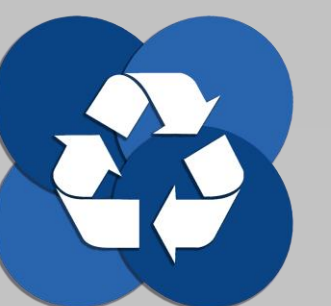
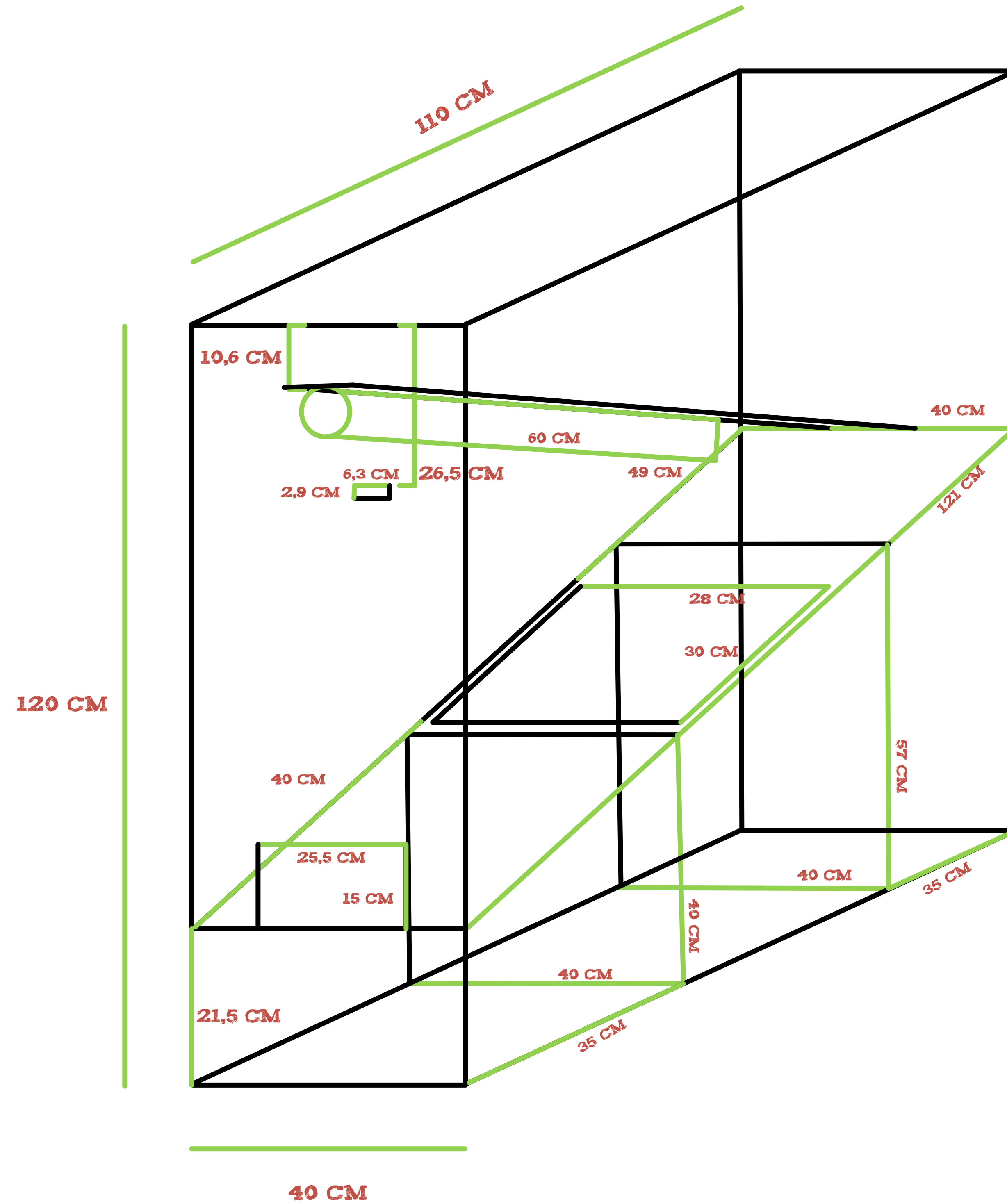

CANASTA RECICLADORA INTELIGENTE

ESTRUCTURA LATERAL MEDIDAS (IMPRIMIR)

